

OPIS TECHNICZNY

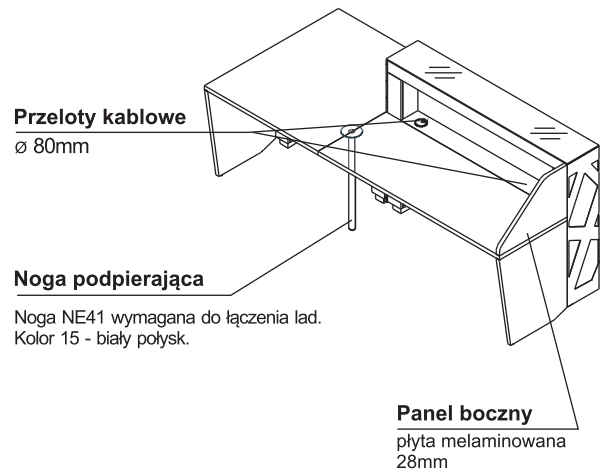

WYMIARY

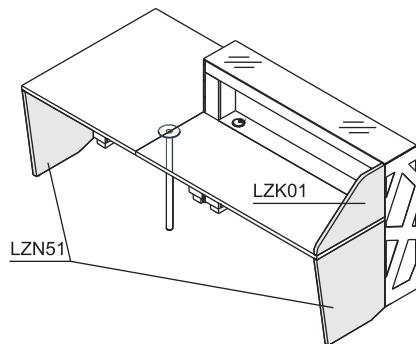

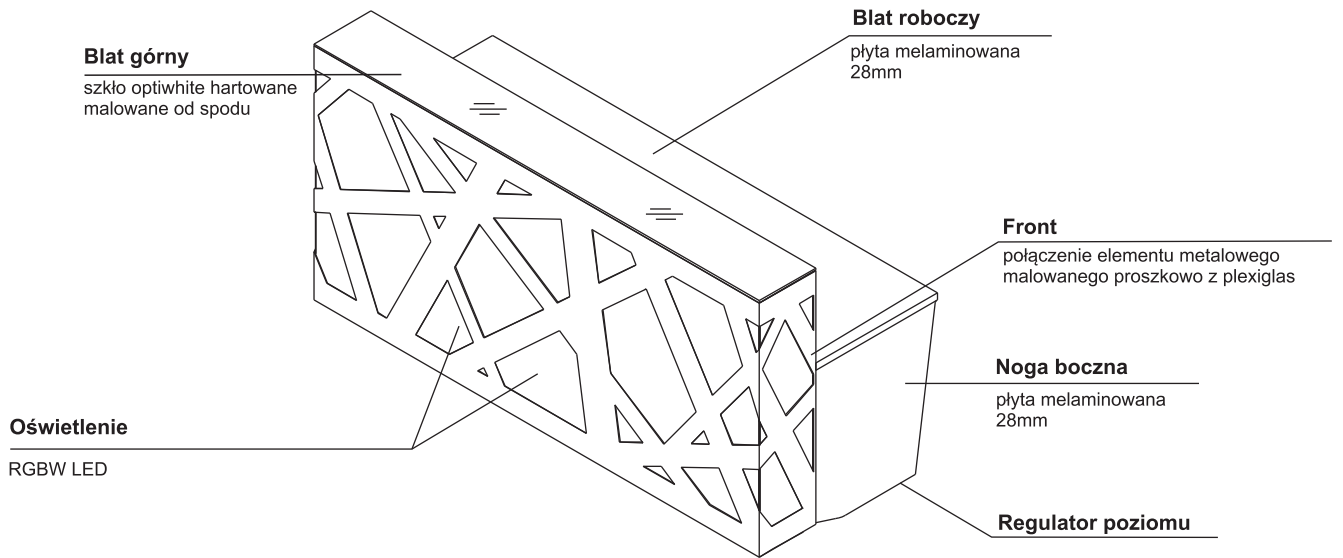
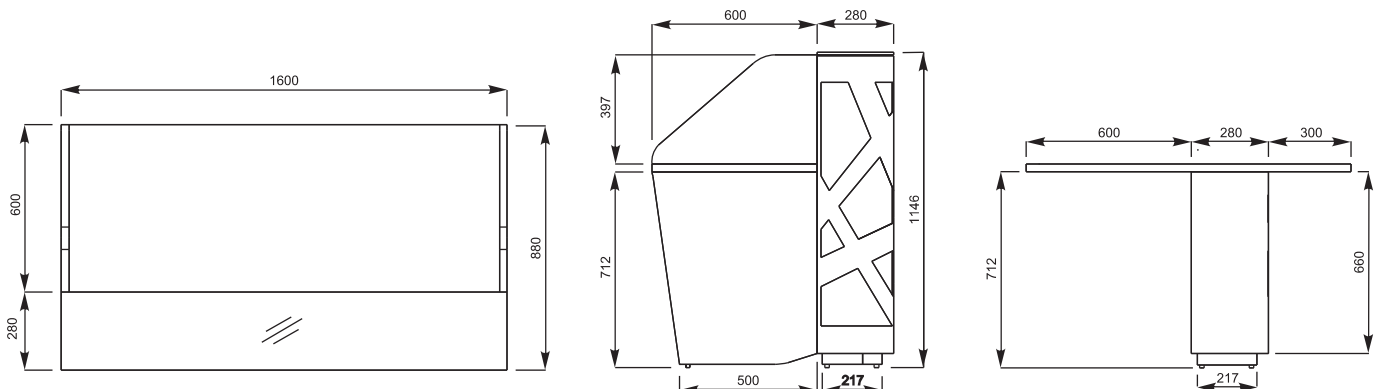

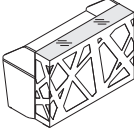
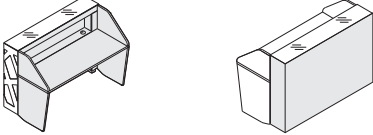
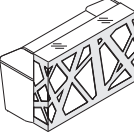
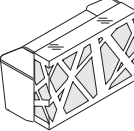

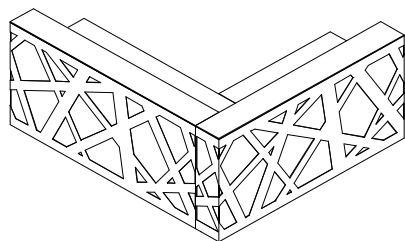
KOLORYSTYKA

SZKŁO HARTOWANE	
67-BIAŁY PASTEL	
15-BIAŁY POLYSK	
PLEKSIKLAS BIAŁY	

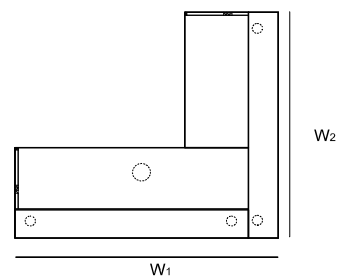
UKŁADY ŁAD

LZN51+LZG22+LZB22+NE41+LZG22+LZB22M



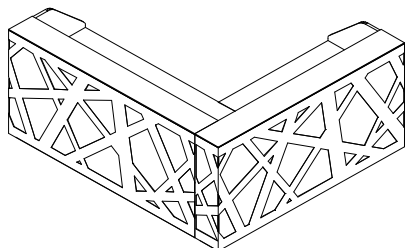

SYMBOL	WYMIARY [mm]					PLN				UWAGI
	W ₁	W ₂	D ₁	D ₂	H		kg	m ³	szt	
LZG44	2480	2200	-	-	1146		293.7	3.186	18	

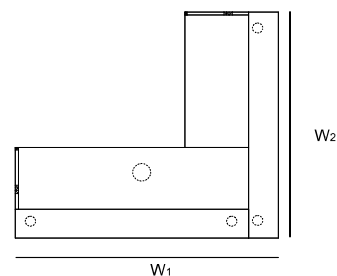

LZK01+LZN51+LZG22+LZB22+NE41+LZG22+LZB22M





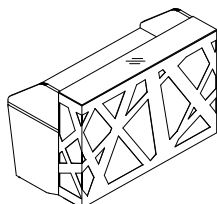

SYMBOL	WYMIARY [mm]					PLN				UWAGI
	W ₁	W ₂	D ₁	D ₂	H		kg	m ³	szt	
LZG45	2480	2200	-	-	1146		300.7	3.206	19	

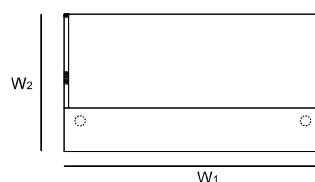



LZ034 - LZK01+LZN51+LZG16+LZB16
 LZ046 - LZK01+LZN51+LZG22+LZB22+NE41



SYMBOL	WYMIARY [mm]					PLN				UWAGI
	W ₁	W ₂	D ₁	D ₂	H		kg	m ³	szt	
LZG34	1600	880	-	-	1146		131.9	1.250	9	
LZG46	2200	880	-	-	1146		165.4	1.648	10	

LEGENDA:
 - WAGA NETTO

 - OBJĘTOŚĆ

 - ILOŚĆ PACZEK

UKŁADY LAD

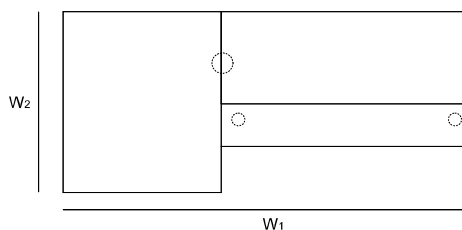
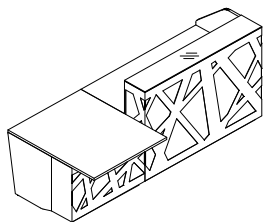

1xNE41 16 16
LZN51+LZG10+2xNE41+LZG22+LZB22+LZK01

SYMBOL	WYMIARY [mm]					PLN				UWAGI
	W ₁	W ₂	D ₁	D ₂	H		kg	m ³	szt	
LZG50	2600	1180	-	-	1146		218.4	1.822	15	
LZG51	3200	1180	-	-	1146		250.4	2.203	15	

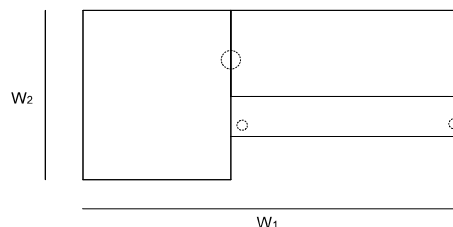
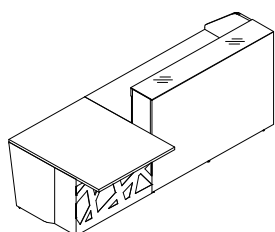

LZB16+LZG16M+LZG10+LZN51+LZK01+NE41

SYMBOL	WYMIARY [mm]					PLN				UWAGI
	W ₁	W ₂	D ₁	D ₂	H		kg	m ³	szt	
LZG56	2600	1180	-	-	1146		220.4	1.822	15	

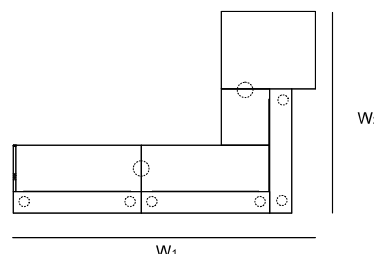
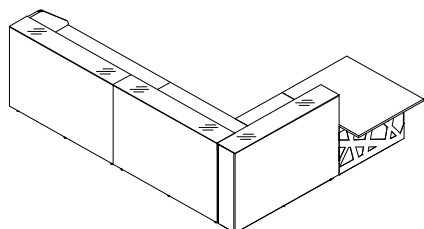

3xLZG16M+LZG10+LZK01+LZN51+LZB16M+2xLZB16+3xNE41

SYMBOL	WYMIARY [mm]					PLN				UWAGI
	W ₁	W ₂	D ₁	D ₂	H		kg	m ³	szt	
LZG57	3200	2880	-	-	1146		439.2	4.215	31	

LEGENDA:

- WAGA NETTO

- OBJĘTOŚĆ

- ILOŚĆ PACZEK

UKŁADY ŁAD

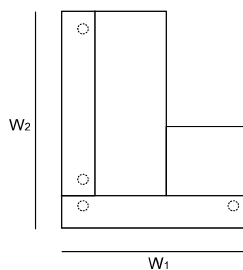
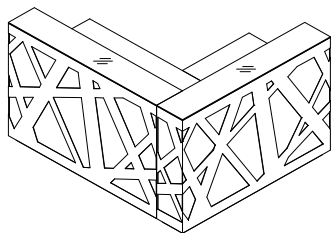

LZN51+LZG16W+LZB16+LZG16+LZB16M

SYMBOL	WYMIARY [mm]					PLN				UWAGI
	W ₁	W ₂	D ₁	D ₂	H		kg	m ³	szt	
LZG32	1600	1880	-	-	1146		227.5	2.395	16	

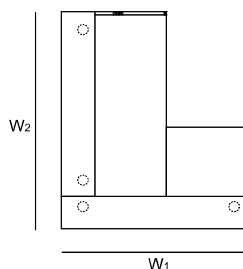
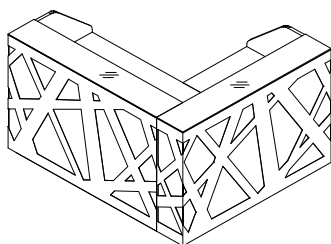

LZK01+LZN51+LZG16+LZB16+LZG16+LZB16M

SYMBOL	WYMIARY [mm]					PLN				UWAGI
	W ₁	W ₂	D ₁	D ₂	H		kg	m ³	szt	
LZG35	1600	1880	-	-	1146		234.5	2.414	17	

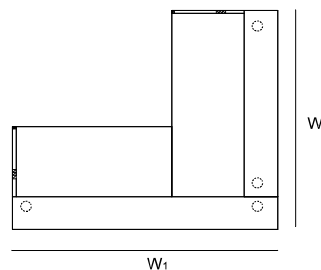
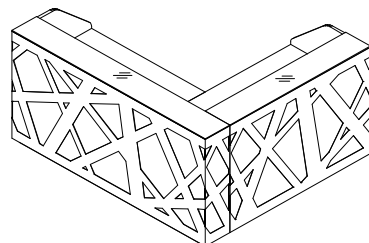

LZK01+LZN51+LZG22+LZB22M+LZG16+LZB16

SYMBOL	WYMIARY [mm]					PLN				UWAGI
	W ₁	W ₂	D ₁	D ₂	H		kg	m ³	szt	
LZG36	2200	1880	-	-	1146		266.5	2.807	17	

LEGENDA:

- WAGA NETTO

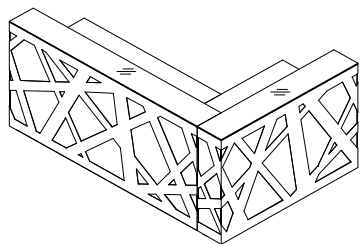

- OBJĘTOŚĆ

- ILOŚĆ PACZEK

UKŁADY LAD

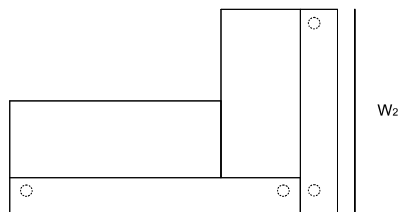
LZN51+LZG22+LZB16+LZG16+LZB22M

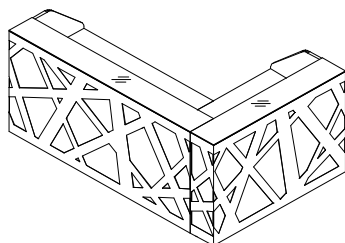

W₁W₂

SYMBOL	WYMIARY [mm]					PLN				UWAGI
	W ₁	W ₂	D ₁	D ₂	H		kg	m ³	szt	
LZG38	2480	1600	-	-	1146		259.5	2.788	16	

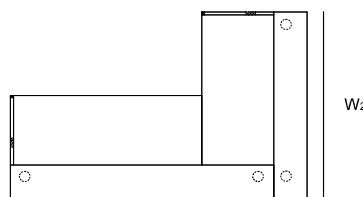

LZK01+LZN51+LZG22+LZB16+LZG16+LZB22M

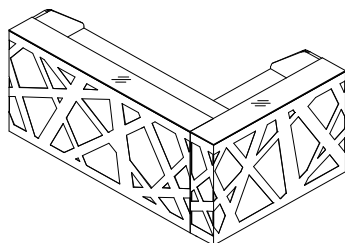

W₁W₂

SYMBOL	WYMIARY [mm]					PLN				UWAGI
	W ₁	W ₂	D ₁	D ₂	H		kg	m ³	szt	
LZG40	2480	1600	-	-	1146		266.5	2.807	17	



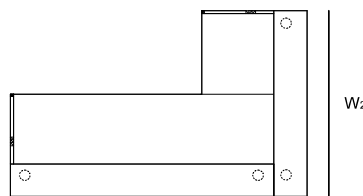

LZK01+LZN51+LZG22+LZB22+NE41+LZG16+LZB16M

W₁W₂

SYMBOL	WYMIARY [mm]					PLN				UWAGI
	W ₁	W ₂	D ₁	D ₂	H		kg	m ³	szt	
LZG42	2480	1600	-	-	1146		265.9	2.811	15	

LEGENDA:

 - WAGA NETTO

 - OBJĘTOŚĆ

 - ILOŚĆ PACZEK

UKŁADY ŁAD

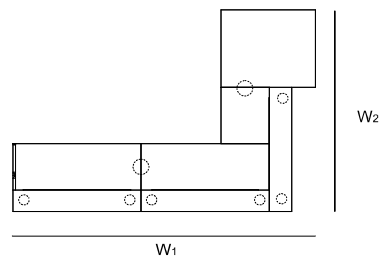
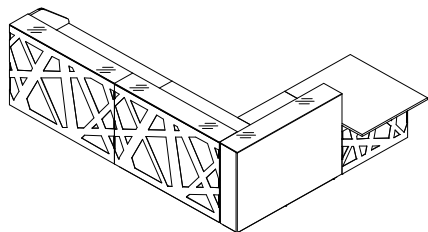

LZG16M+2xLZG16+LZG10+LZK01+LZN51+LZB16M+2xLZB16+3xNE41

SYMBOL	WYMIARY [mm]					PLN				UWAGI
	W ₁	W ₂	D ₁	D ₂	H		kg	m ³	szt	
LZG58	3808	2880	-	-	1146		435.2	4.215	31	

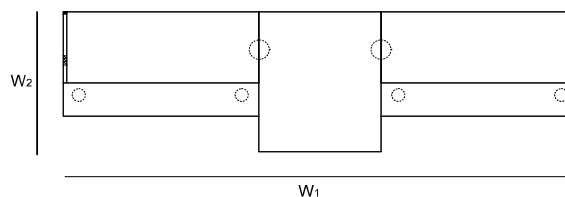
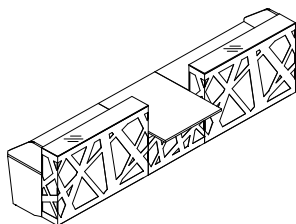

¹⁶ LZN51+¹⁶ LZG22+¹⁶ LZB22+¹⁶ 2xNE41+LZG10+¹⁶ LZG22+¹⁶ 3xNE41+LZB22+LZK01

SYMBOL	WYMIARY [mm]					PLN				UWAGI
	W ₁	W ₂	D ₁	D ₂	H		kg	m ³	szt	
LZG52	4200	1180	-	-	1146		329.8	3.034	23	
LZG53	4800	1180	-	-	1146		363.3	3.433	24	
LZG54	5400	1180	-	-	1146		396.8	3.831	25	

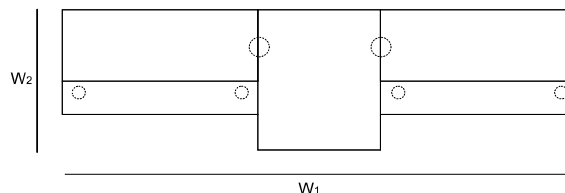
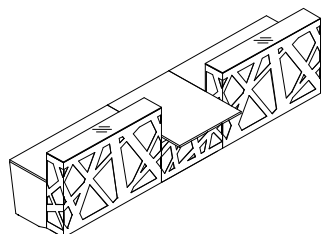

LZN51+LZG16+LZB16+NE41+LZG10+NE41+LZG16+LZB16

SYMBOL	WYMIARY [mm]					PLN				UWAGI
	W ₁	W ₂	D ₁	D ₂	H		kg	m ³	szt	
LZG55	4200	1180	-	-	1146		322.8	3.015	22	

LEGENDA:

- WAGA NETTO

- OBJĘTOŚĆ

- ILOŚĆ PACZEK

UKŁADY ŁAD

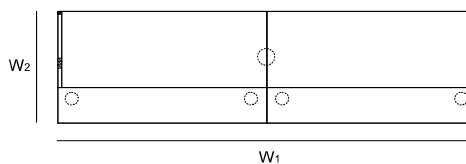
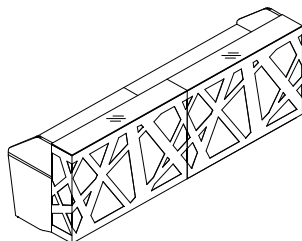

16 16 1xNE41 16 16
16 16 2xNE41 22 22
LZK01+LZN51+LZG22+LZB22+3xNE41+LZG22+LZB22

SYMBOL	WYMIARY [mm]					PLN	⚖️	📦	📦	UWAGI
	W ₁	W ₂	D ₁	D ₂	H					
LZG60	3200	880	-	-	1146		243.3	2.462	17	
LZG61	3800	880	-	-	1146		276.8	2.860	18	
LZG62	4400	880	-	-	1146		310.3	3.258	19	

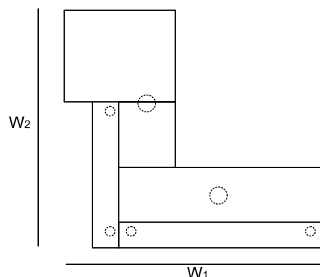
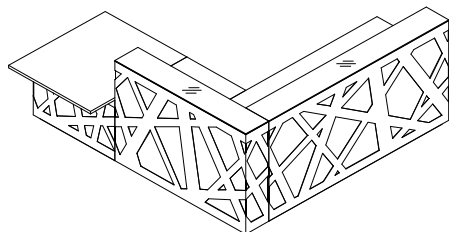

LZN51+LZG10+NE41+LZG16+LZB16M+LZG22+LZB22+NE41

SYMBOL	WYMIARY [mm]					PLN	⚖️	📦	📦	UWAGI
	W ₁	W ₂	D ₁	D ₂	H					
LZG64	2600	2780	-	-	1146		346.8	3.365	22	

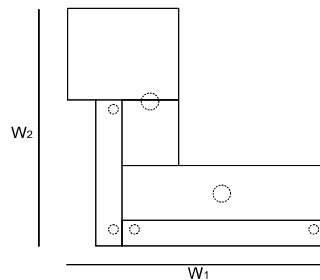
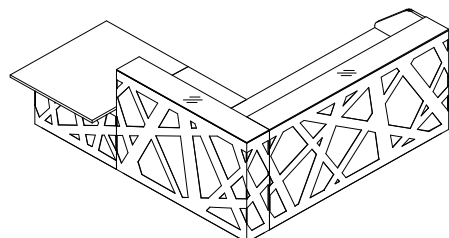

LZN51+LZG10+NE41+LZG16+LZB16M+LZG22+LZB22+NE41+LZK01



SYMBOL	WYMIARY [mm]					PLN	⚖️	📦	📦	UWAGI
	W ₁	W ₂	D ₁	D ₂	H					
LZG63	2600	2780	-	-	1146		353.8	3.384	23	

LEGENDA:









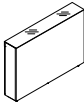

⚖️ - WAGA NETTO

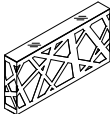
📦 - OBJĘTOŚĆ

📦 - ILOŚĆ PACZEK

WIDOK i RZUT OBIEKTU	WYMIARY [mm]			SYMBOL	CENA NETTO PLN				UWAGI
	SZEROKOŚĆ	GLĘBOKOŚĆ	WYSOKOŚĆ			kg	m ³	szt	

ELEMENTY SKŁADOWE



	1600	280	1146	LZG16M		93.5	1.147	4	
	1600	280	1146	LZG16		91.5	1.147	4	
	2200	280	1146	LZG22		116.5	1.527	4	
	1000	1180	740	LZG10		85.0	0.555	5	
	720	600	28	LZB16M		10.4	0.017	3	
	1320	600	28	LZB22M		18.1	0.031	4	
	1600	600	28	LZB16		18.4	0.049	3	
	2200	600	28	LZB22		25.4	0.050	3	
	600	28	397	LZK01		7.0	0.020	1	
	600	28	712	LZN51		15.0	0.035	1	
	40	40	712	NE41		1.5	0.017	1	noga okrągła

LEGENDA:

 - WAGA NETTO

 - OBJĘTOŚĆ

 - ILOŚĆ PACZEK

WIDOK i RZUT OBIEKTU	WYMIARY [mm]			SYMBOL	CENA NETTO PLN				UWAGI
	SZEROKOŚĆ	GLĘBOKOŚĆ	WYSOKOŚĆ			kg	m3	szt	

ELEMENTY SKŁADOWE

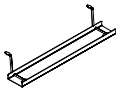
	460	70	87	E64		0.0	0.000	0	kanal kablowy 09-aluminium
---	-----	----	----	------------	--	-----	-------	---	----------------------------

LEGENDA:

 - WAGA NETTO

 - OBJĘTOŚĆ

 - ILOŚĆ PACZEK